

# 1b

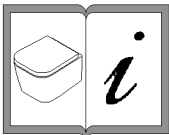

| X  |    | Z    |
|----|----|------|
| 22 | 72 | 79.5 |
| 23 | 73 | 80.5 |
| 24 | 74 | 81.5 |
| 25 | 75 | 82.5 |
| 26 | 76 | 83.5 |

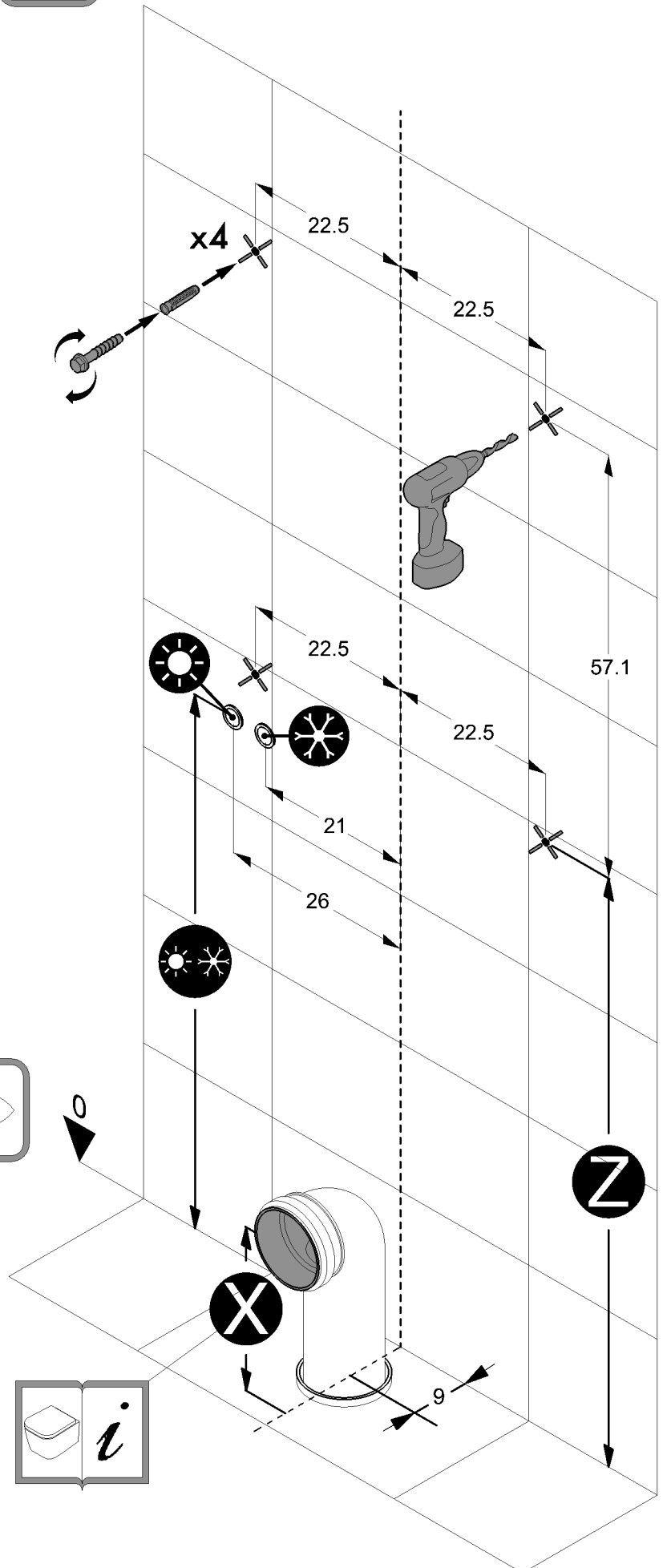
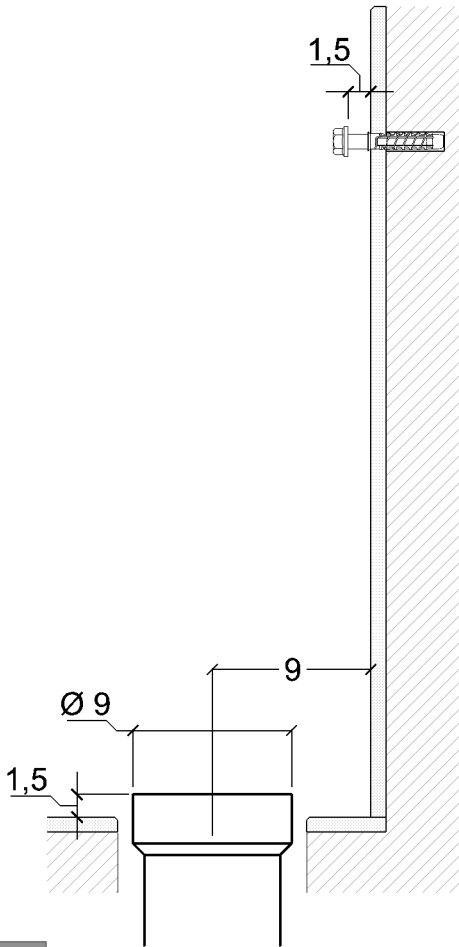
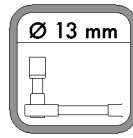
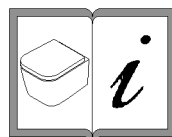

# 1a

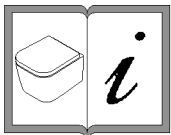
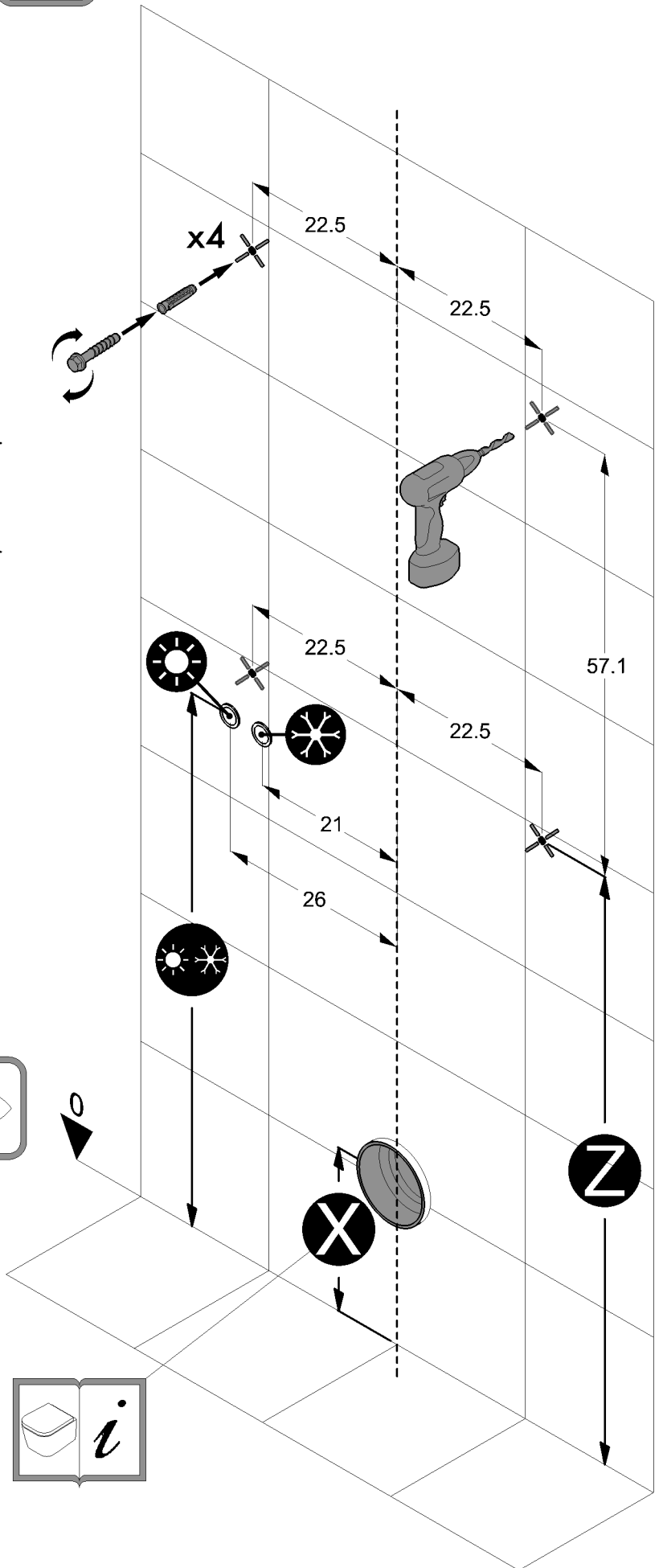
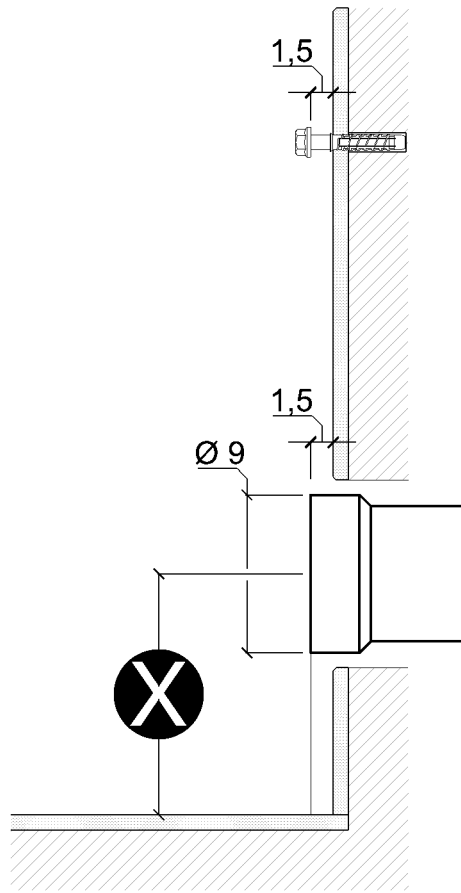
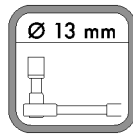

| X  |    | Z    |
|----|----|------|
| 22 | 72 | 79.5 |
| 23 | 73 | 80.5 |
| 24 | 74 | 81.5 |
| 25 | 75 | 82.5 |
| 26 | 76 | 83.5 |

